

LUMIÈRE CONFIGURATION - B

LUMIÈRE LIGHT WALL

PRODUCT CODE: LLW10B



On frame On graphic

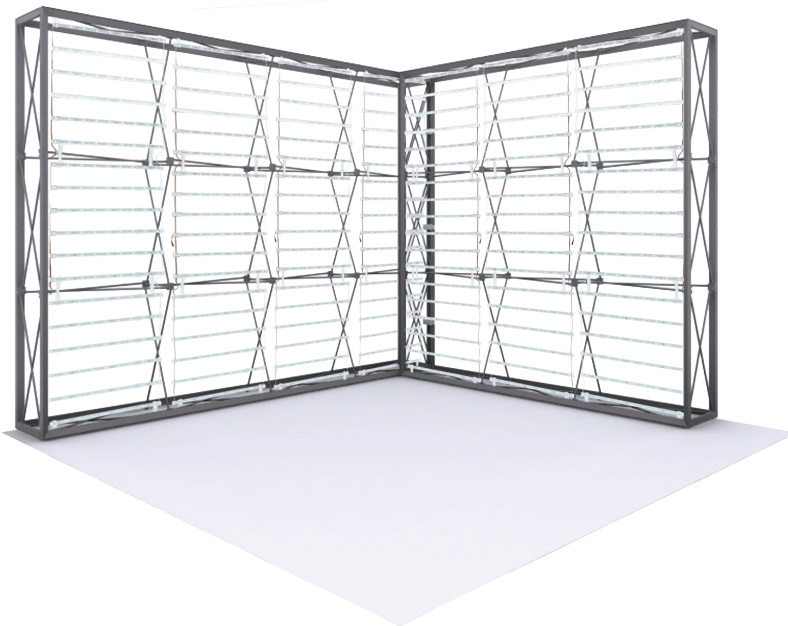

L Link Connector

PRODUCT DESCRIPTION

Illuminate your message with the Lumiere Light Wall! Lumiere ladder lights make backlit graphics pop on this innovative combo display of silicone-edge graphics and portable RPL fabric pop ups. Plus, the Lumiere shrinks down in size: simply collapse the geometric frame and the SEG bungeed channel bars, and fold or roll the fabrics graphics. Setup requires 1 person and 5-10 minutes. SEG portability is easy and stylish.

DISPLAY DIMENSION	236.2" W x 88.6" H x 14.5" D
GRAPHIC DIMENSIONS	
4X3 MAIN GRAPHICS	118.5" W x 89" H (2 Graphics)
4X3 END CAP GRAPHICS	14.25" W x 89" H (2 Graphics)
3X3 MAIN GRAPHICS	89" W x 89" H (2 Graphics)
3X3 END CAP GRAPHICS	14.25" W x 89" H (1 Graphic)

GRAPHIC MATERIAL

UV Backlit Fabric

GRAPHIC FINISHING

Silicone beading is sewn around the perimeter of the fabric graphic. Silicone beading is hidden from view once installed.

DISPLAY CONSTRUCTION

Aluminum Frame

LADDER LIGHTS SPECIFICATION

EACH LIGHT BEAD	1.0W
ANGLE	170°
OPERATING VOLTAGE	DC12V/24V
TOTAL WATTAGE	735W
TOTAL AMPERAGE	31.5A

TRANSFORMER SPECIFICATION

OUTPUT	24V/3.75A
INPUT	AC100-240V/1.3A

SHIPPING WEIGHTS & DIMENSIONS

Lumiere Ladder Lights - 4 Units	
Shipping Weight	29 lbs
Shipping Dimensions	14" L x 12.5" W x 32.5" H
Lumiere Ladder Lights - 3 Units	
Shipping Weight	23 lbs
Shipping Dimensions	12" L x 12.25" W x 33.5" H
4x3 Lumiere Light Wall (1 box)	
Shipping Weight	35 lbs (frame only) 39 lbs (with graphics)
Shipping Dimensions	34" L x 14" W x 9" H
3x3 Lumiere Light Wall (1 box)	
Shipping Weight	28 lbs (frame only) 32 lbs (with graphics)
Shipping Dimensions	34" L x 14" W x 9" H

GRAPHIC TURN AROUND TIME

2 business days after proof approval

AVAILABILITY	CA and PA
---------------------	-----------

Please Note: Lumiere Ladder Light sets are placed on the front side of the frame only. They are not double-sided and may not be used as so.

AVAILABLE ACCESSORIES



La Caja Case



Genie Counter Case



Internal Showcase



Lumiere Jumper Cable*

LUMIÈRE CONFIGURATION - B

LUMIÈRE LIGHT WALL

PRODUCT CODE: LLW10B

PARTS LIST



Qty 1 - 4x3 Pop Up Frame



Qty 1 - 3x3 Pop Up Frame



Qty 4 - 4 Section Channel Bars



Qty 12 - 3 Section Channel Bars

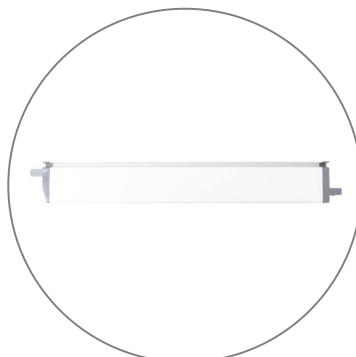

Qty 8 - End Cap Channel Bars



Qty 2 - Carry Bags



Qty 4 - Channel Bar Bags

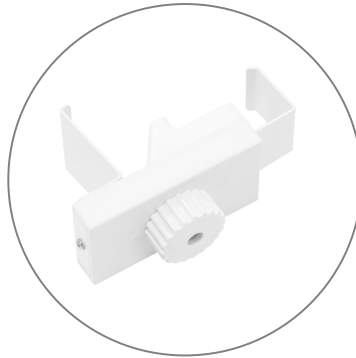

Qty 3 - L Link Connectors

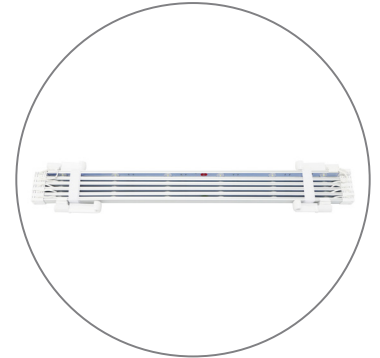

Qty 7 - Ladder Light Sets



Qty 7 - Transformers



Qty 7 - Transformer Power Cords



Qty 7 - Ladder Light Travel Bags

LUMIÈRE CONFIGURATION - B

LUMIÈRE LIGHT WALL

PRODUCT CODE: LLW10B

SET UP INSTRUCTIONS 1/2

Set Up Pop Up Frame



a. Place frame with the adjustable feet facing down.

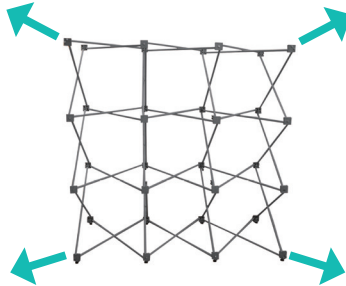

b. Expand the frame.

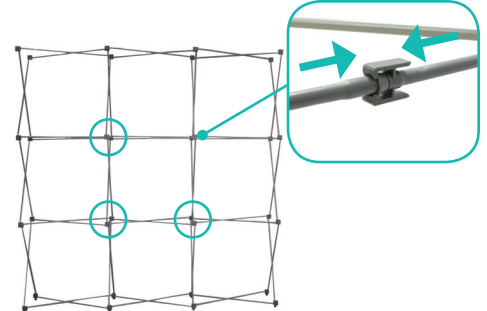

c. Close frame by pushing the outside of the frame until male and female ends connect.

Insert Channel Bars

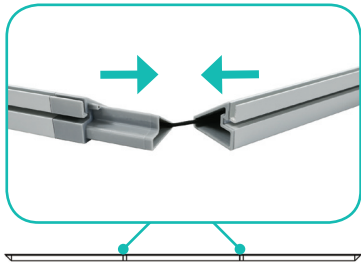

a. Expand each channel bar. Follow bungee to connect.

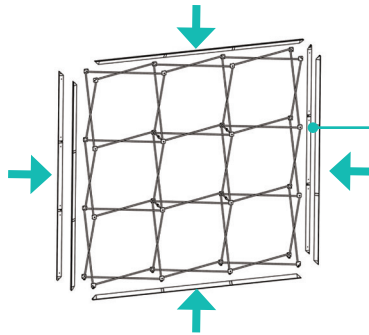

b. Attach channel bars to frame.

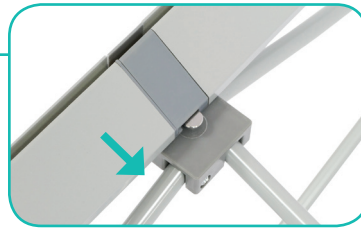

c. Slide channels bars onto frame, from top to bottom, then secure onto metal peg.



d. Attach the top and bottom end-caps on each side of the frame.

Unfold The Hooks



a. Locate each hook.



b. Turn each hook outward.



c. Twist each hook to face the front of the ladder light.

LUMIÈRE CONFIGURATION - B

LUMIÈRE LIGHT WALL

PRODUCT CODE: LLW10B

SET UP INSTRUCTIONS 2/2

Hook Ladder Lights



a. Hang ladder lights from top "x" bar. **Note:** Make sure to follow label that says "UP" or "DOWN".



b. Hang ladder lights in each section of the frame until reaching the bottom of the frame.

Connect Ladder Lights

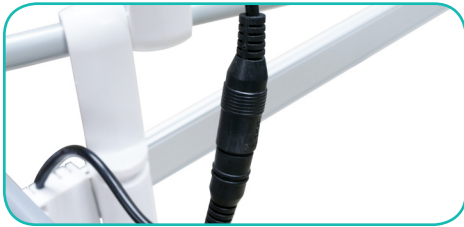

a. Connect each ladder light together using the barrel connectors.



b. Connect bottom set of lights to the LED Driver using the barrel connectors



c. Insert power cord to the LED Driver. Plug other side into your main power outlet.

Install Graphic



a. In each corner, insert the silicone edge beading into the groove.



b. Then insert the remainder of the beading. Repeat blackout installation for the back frame.



c. Then repeat graphic installation on the end caps for each side.

LUMIÈRE CONFIGURATION - B

LUMIÈRE LIGHT WALL

PRODUCT CODE: LLW10B

SET UP INSTRUCTIONS

Connecting Return Wall

Front View

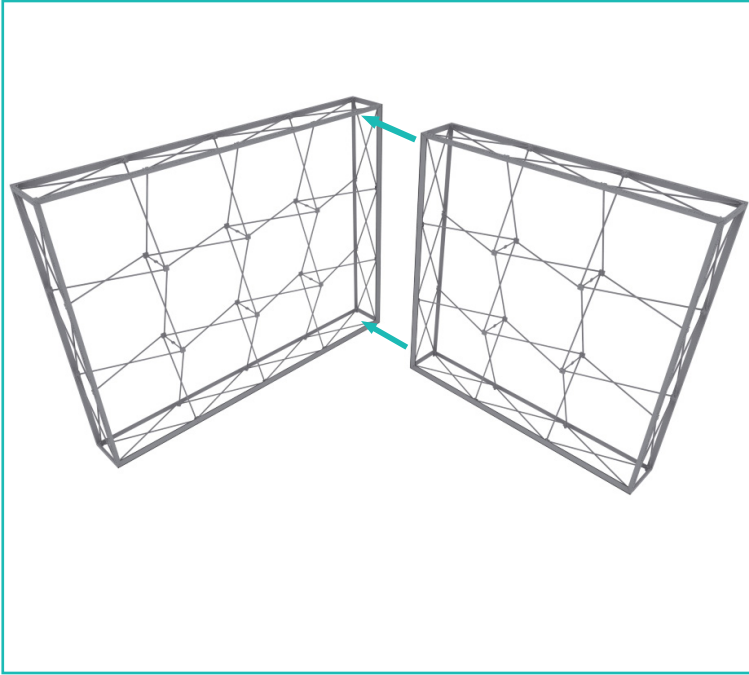

Back View

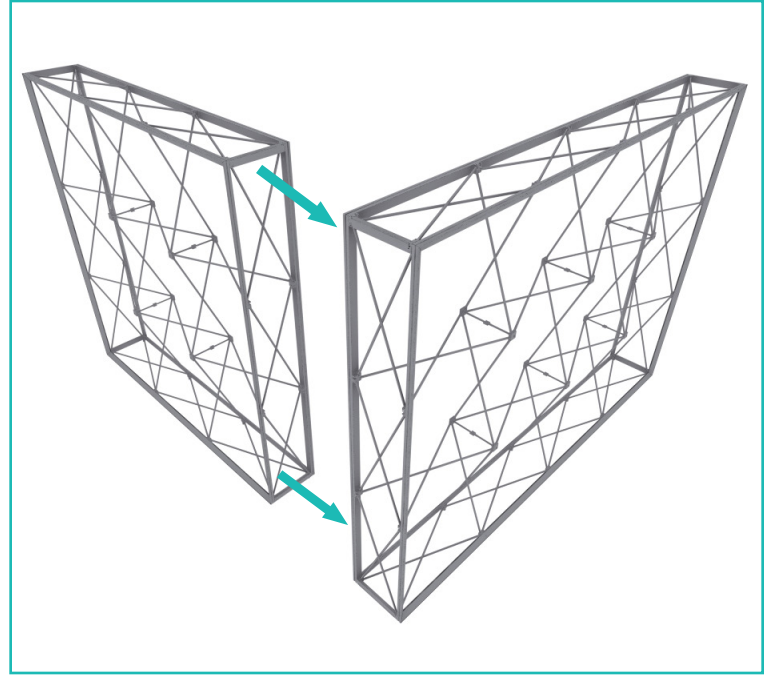

Adjoin the 3x3 frame perpendicular (90° angle) to the front side of the 4x3 frame.

Note: Rendering shown without graphics for clarity. 4x3 front side graphic must be installed before connecting frames.

L Link Connection



*Starting from behind, pull the 4x3 graphic away to make space for L Connector.



Slide L Connector onto the channel bars of both frames.

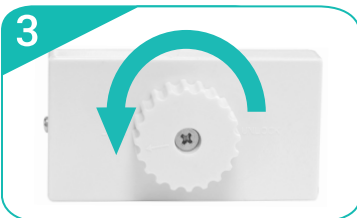

Turn dial to the left to lock the L Connector in place. Repeat for each vertical section (3 total).

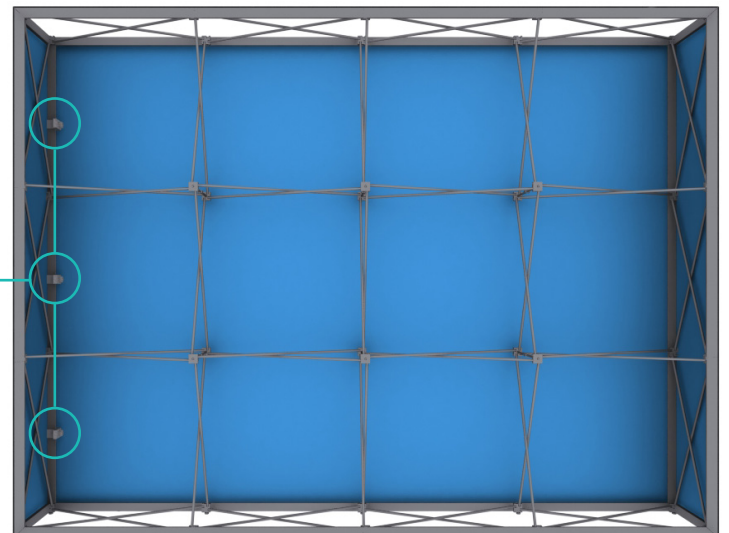

*Back side of 4x3 shown above.

LUMIÈRE CONFIGURATION - B

LUMIÈRE LIGHT WALL

PRODUCT CODE: LLW10B

TEMPLATE GUIDE

Front View

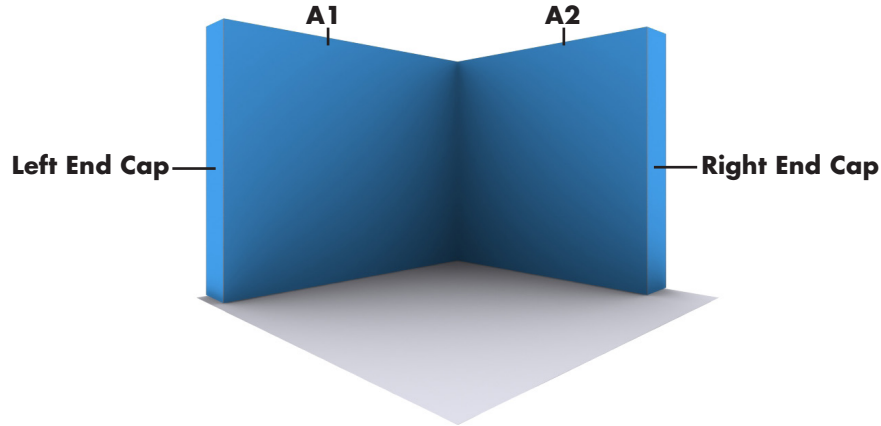

Back View

