

# LUMIÈRE CONFIGURATION I (BACKLIT)

LUMIÈRE LIGHT WALL  
PRODUCT CODE: LLWIG

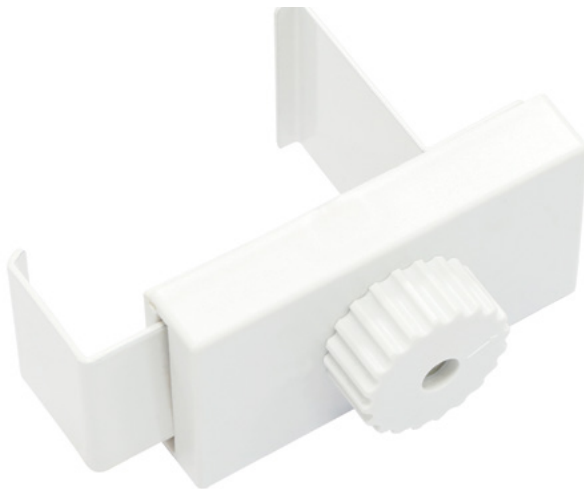

On frame On graphic

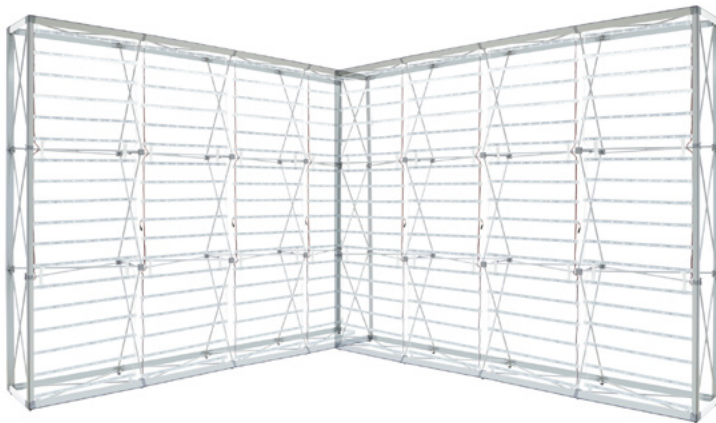

L Link Connector

## PRODUCT DESCRIPTION

Introducing the Lumiere Light Wall! A combination of innovative silicone-edge graphics and RPL fabric pop ups offers an easier and more cost effective SEG option. This SEG style display has the depth of the RPL so you can expose more of your message using endcap graphics. The Lumiere shrinks down in size - simply collapse the geometric frame and the SEG bungeed channel bars, and fold or roll the fabric graphics. Setup can be done by 1 person and in 5-10 minutes. SEG portability is easy and stylish.

DISPLAY DIMENSION	118.5"W x 89"H x 103"D
GRAPHIC DIMENSIONS	4x3: 117.5"W x 88"H Qty.3 4x3/Endcap: 101.8"W x 88"H Qty.1 Endcaps: 130.8"W x 88"H Qty.2

## GRAPHIC MATERIAL

Backlit Fabric

## GRAPHIC FINISHING

SEG Finishing (Silicone Edge Graphic)

## DISPLAY CONSTRUCTION

Aluminum Frame

## LADDER LIGHT SPECIFICATION

EACH LIGHT BEAD	0.8W
ANGLE	160°
OPERATION VOLTAGE	DC12V/24V
TOTAL WATTAGE	2332.8W
TOTAL AMPERAGE	194.4A

## TRANSFORMER SPECIFICATION

OUTPUT	12V/29A
INPUT	100-120VAC/6.8A 200-240VAC/3.4A 50/60Hz

## SHIPPING WEIGHTS & DIMENSIONS

Shipping Weight (4 boxes)	Qty.2 - 4x3: 32lbs (frame only) 40lbs (with graphics) Qty.2 - 4 Light Sets: 32lbs each
Shipping Dimensions (4 boxes)	Qty.2 - 34"L x 14"W x 9"H Qty.2 - 29.75"L x 5.5"W x 5.5"H

## GRAPHIC TURN AROUND TIME

2 business days after proof approval

## AVAILABLE ACCESSORIES

Lumiere LED Lights 150w (Black & Silver)	Lumiere Front Lit LED Lights (Black & Silver)
T135 LED Light	La Caja Case
Tahoe Case	

AVAILABILITY	CA and PA
--------------	-----------

# LUMIÈRE CONFIGURATION I (BACKLIT)

LUMIÈRE LIGHT WALL  
PRODUCT CODE: LLWIG



On frame On graphic

## PARTS LIST



Qty.2 - 10' x 7.5' Frame



Qty.8 - 3 Section Channel Bars



Qty.8 - 4 Section Channel Bars



Qty.8 - Endcap Channel Bar



Qty.3 - L Link Connector



Qty.4 - Channel Bar Bags

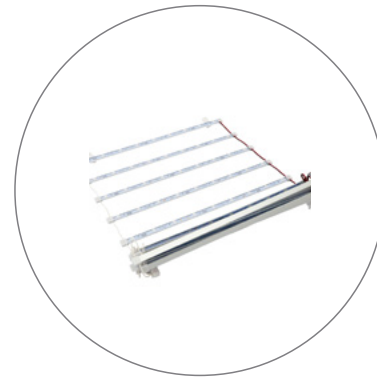

Qty.8 - Ladder Lights



Qty.32 - Top/Bottom Brackets



Qty.32 - Middle Brackets

# LUMIÈRE CONFIGURATION I (BACKLIT)

LUMIÈRE LIGHT WALL  
PRODUCT CODE: LLWIG



On frame On graphic

## ACCESSORIES



La Caja Case



Tahoe Case



150w Black Light



150w Silver Light



Front Lit LED Black Light



Front Lit LED Silver Light



T135 LED Light

# LUMIÈRE CONFIGURATION I (BACKLIT)

LUMIÈRE LIGHT WALL  
PRODUCT CODE: LLWIG



On frame On graphic

## SET UP INSTRUCTIONS

### Set Up Pop Up Frame



a. Place frame with the adjustable feet facing down.

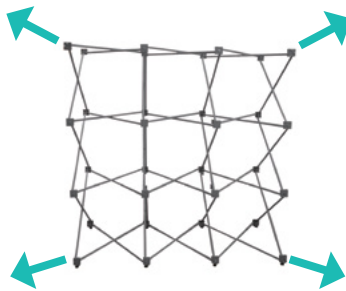

b. Expand the frame.

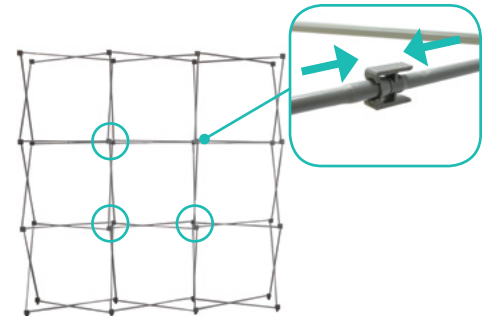

c. Close frame by pushing the outside of the frame until male and female ends connect.

### Insert Channel Bars

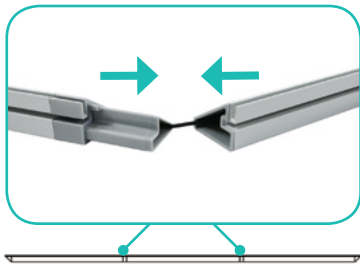

a. Expand each channel bar. Follow bungee to connect.

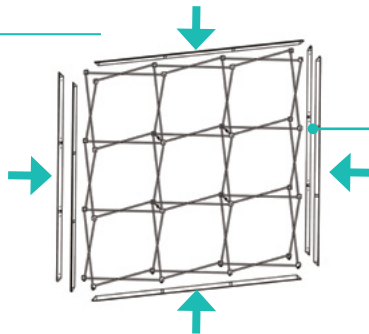

b. Attach channel bars to frame.

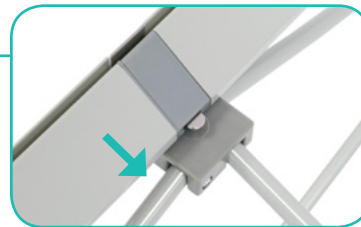

c. Slide channels bars onto frame, from top to bottom, then secure onto metal peg.



d. Attach the top and bottom end caps on each side of the frame.

### Install Graphic



a. In each corner, insert the silicone edge beading into the groove.



b. Then insert the remainder of the beading.



c. Repeat graphic installation on the end caps.

### Optional Accessories

#### Light Bracket:

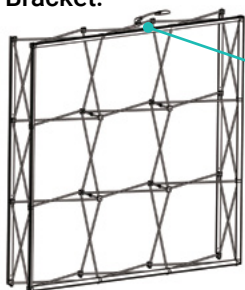

a. Snap the LED Light Bracket on top of the frame. Then slide the LED Light onto the bracket.



#### Stabilized Feet:

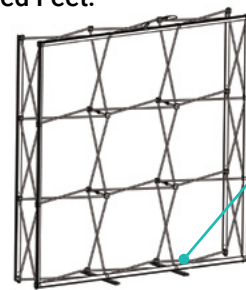

a. From the back, lift frame and insert adjustable feet onto stabilized feet. Then slide stabilized feet toward and insert onto the adjustable feet.



# LUMIÈRE CONFIGURATION I (BACKLIT)

LUMIÈRE LIGHT WALL  
PRODUCT CODE: LLWIG



On frame On graphic

## Step 1



a. Hang ladder lights by placing the brackets on the top and bottom of the frame.

## Step 2



b. Snap brackets onto the ladder lights on each side. Then place brackets on the top and bottom middle cross sections of the frame.

## Step 3

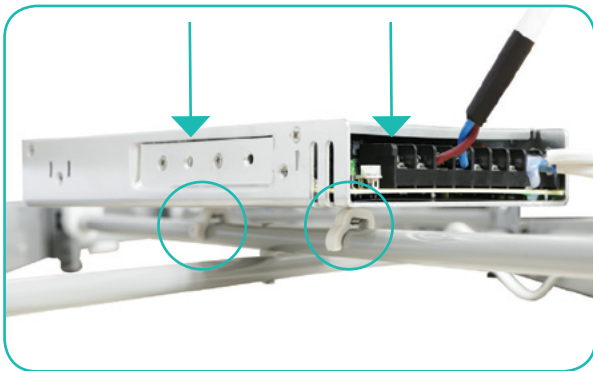

c. Place two transformers on the bottom of the frame by snapping onto each cross sections.

## Step 4

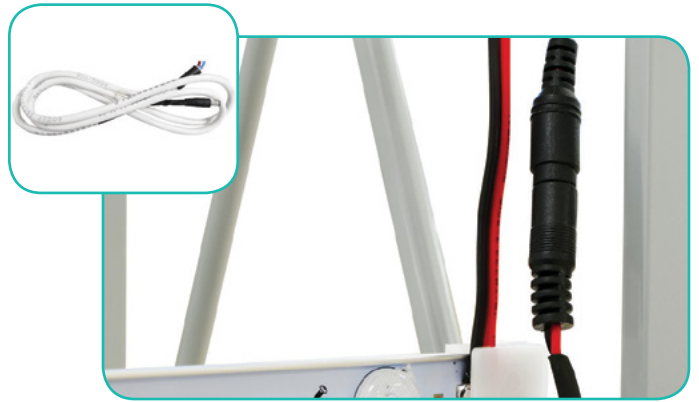

d. Connect transformer cord and ladder light cord together.

## Step 5

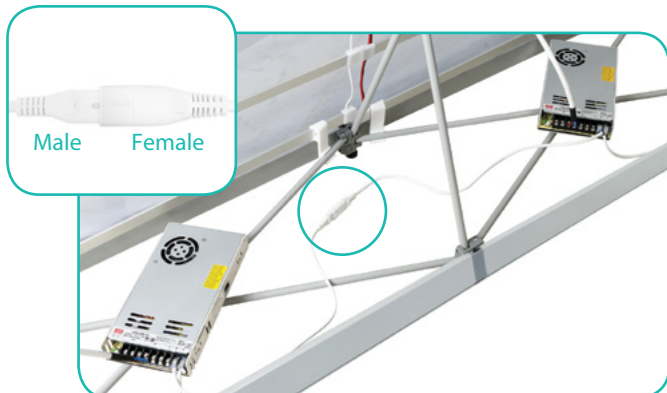

e. Plug each transformers together by connecting male and female connector cords.

## Step 6

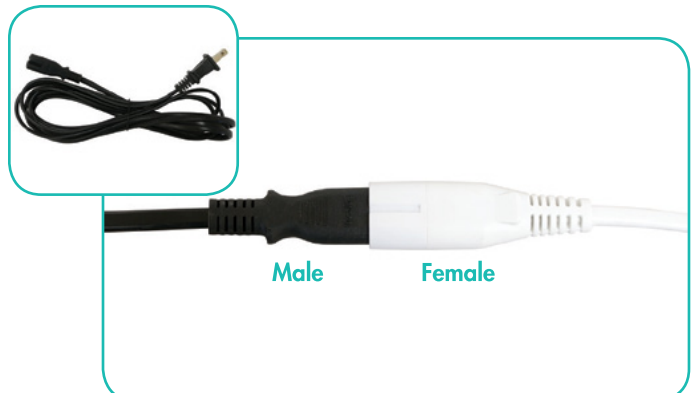

f. Then connect male power cord and female transformer connector cord together.



# LUMIÈRE CONFIGURATION I (BACKLIT)

LUMIÈRE LIGHT WALL  
PRODUCT CODE: LLWIG



On frame On graphic

## SET UP INSTRUCTIONS

(CONFIGURATION I)

### Connecting Return Wall

Front View

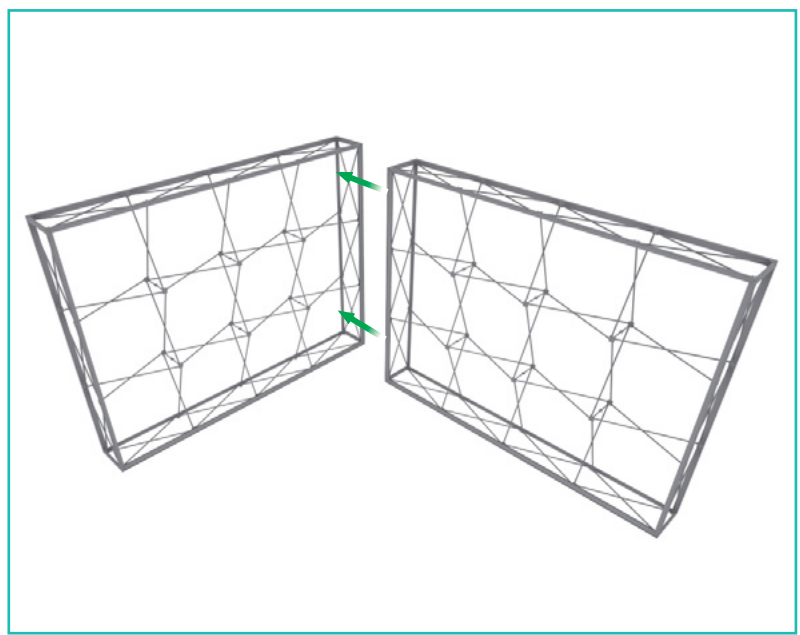

Back View

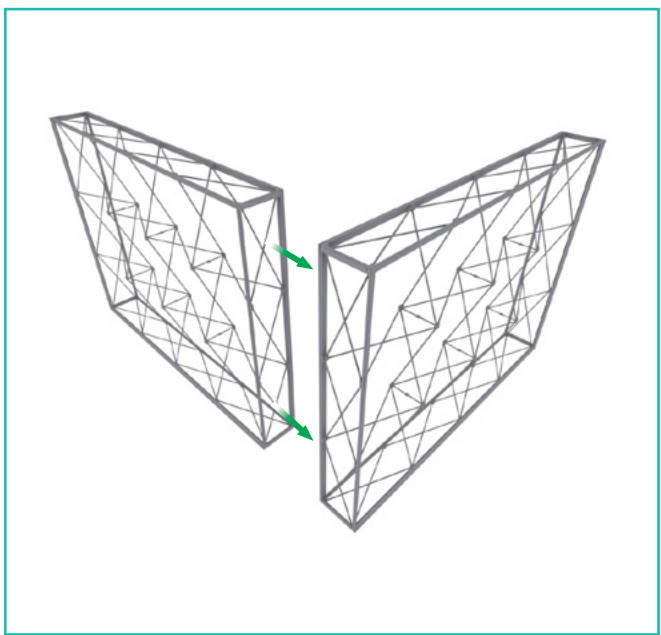

Adjoin the 10' x 7.5' frame perpendicular (90° angle) to the front side of the other 10' x 7.5' frame.

Note: Rendering shown without graphics for clarity. Graphics must be installed before connecting frames.

### L Link Connection



Pull 10' x 7.5' graphic away to make space for L Connector.

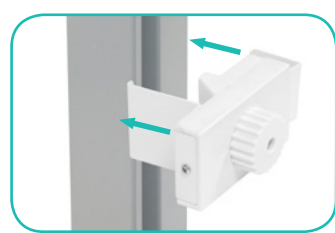

Slide L Connector onto adjacent channel bars (from both frames).

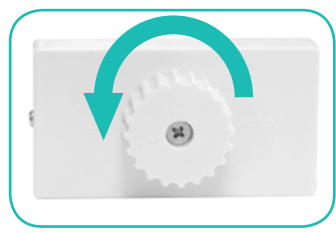

Turn dial to the left to lock the L Link Connector in place. Repeat for each vertical section.

