

QSEG QUEUE STRAIGHT DOUBLE

QSEG MODULAR SEG DISPLAY
 PRODUCT CODE: QSEGSTRQUEUE-2L-FCPG

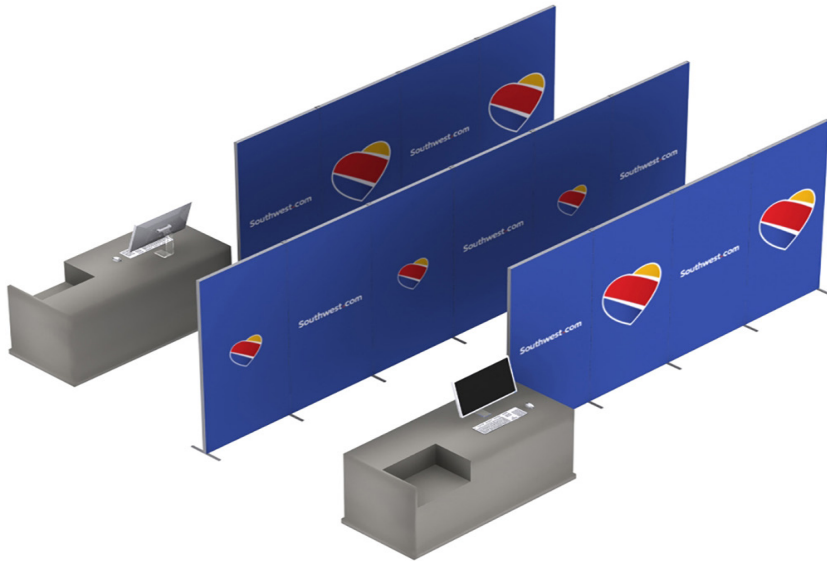

On frame On graphic



PRODUCT DESCRIPTION

Use Qseg for social distancing solutions for work environments as office partitions and cubicles. Help keep safe physical distance between employees and customers with today's health and safety regulations. By strategically placing our lightweight and portable walls. Padded travel bags are included to keep your frames and graphics protected during transport and storage. With many wall sizes and connector accessories. Effortlessly creating numerous configurations that meet your needs. Connector options are either 2 way (90°) or 4 way (180°). Other graphic options are full custom printed dye sublimated graphics or TPU plastic for hygienic sneeze guards and partitions.

DISPLAY DIMENSIONS	236.25"W x 88.5"H (depth varies)
--------------------	----------------------------------

GRAPHIC SIZE (each frame)	41.5" x 91"
---------------------------	-------------

GRAPHIC MATERIAL

Dye Sub Stretch Fabric

GRAPHIC FINISHING

Silicone beading sewn onto edge of graphic

DISPLAY CONSTRUCTION

Aluminum extrusion frame with plastic components

SHIPPING WEIGHTS & DIMENSIONS

Shipping Weight (each box)	16 lbs (SEGO-100x225) (2 box)
	40 lbs (SEGO-300x225) (4 boxes)
Shipping Dimensions (each box)	47.25"W x 4"H x 10.25"D (12box)
	47.25"W x 10.25"H x 10.25"D (4 boxes)

GRAPHIC TURN AROUND TIME

2 business days after proof approval (up to 2 sets)

AVAILABILITY	PFC
--------------	-----

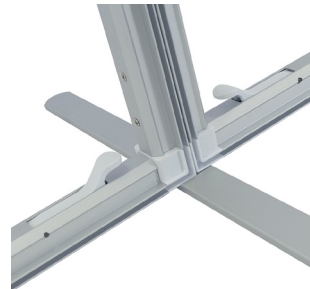
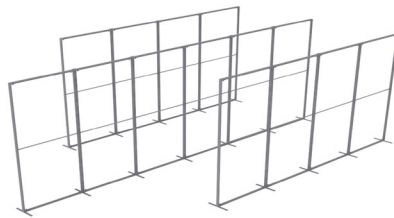
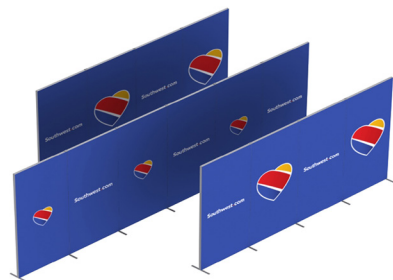

DUAL FOOT CONNECTION



DOUBLE FOOT

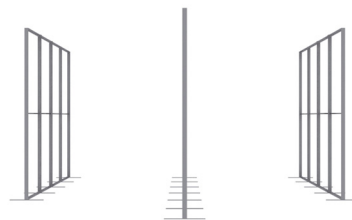
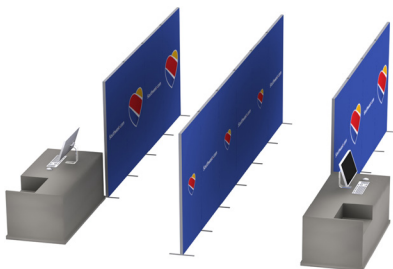

OPTIONAL TPU MATERIAL



STRAIGHT CONNECTION

QSEG QUEUE STRAIGHT DOUBLE BLANK

QSEG MODULAR SEG DISPLAY
 PRODUCT CODE: QSEGSTRQUEUE-2L-UG



On frame On graphic



PRODUCT DESCRIPTION

Use Qseg for social distancing solutions for work environments as office partitions and cubicles. Help keep safe physical distance between employees and customers with today's health and safety regulations. By strategically placing our lightweight and portable walls. Padded travel bags are included to keep your frames and graphics protected during transport and storage. With many wall sizes and connector accessories. Effortlessly creating numerous configurations that meet your needs. Connector options are either 2 way (90°) or 4 way (180°). Other graphic options are full custom printed dye sublimated graphics or TPU plastic for hygienic sneeze guards and partitions.

DISPLAY DIMENSIONS	236.25"W x 88.5"H (depth varies)
GRAPHIC SIZE (each frame)	41.5" x 91"

GRAPHIC MATERIAL

Unprinted Stretch Fabric

GRAPHIC FINISHING

Silicone beading sewn onto edge of graphic

DISPLAY CONSTRUCTION

Aluminum extrusion frame with plastic components

SHIPPING WEIGHTS & DIMENSIONS

Shipping Weight (each box)	16 lbs (SEGO-100x225) (2 box)
	40 lbs (SEGO-300x225) (4 boxes)
Shipping Dimensions (each box)	47.25"W x 4"H x 10.25"D (2 box)
	47.25"W x 10.25"H x 10.25"D (4 boxes)

GRAPHIC TURN AROUND TIME

2 business days after proof approval (up to 2 sets)

AVAILABILITY	PFC
--------------	-----

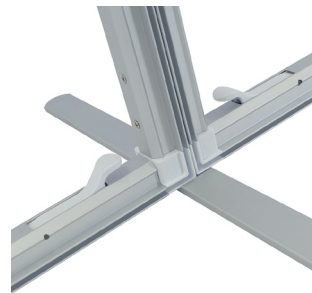
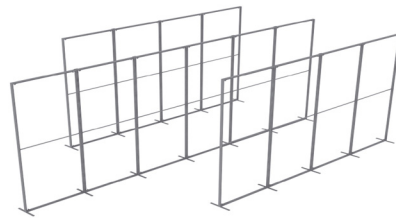

DUAL FOOT CONNECTION



DOUBLE FOOT

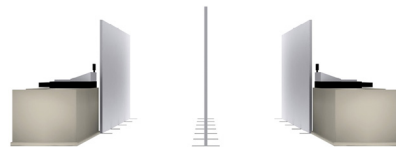
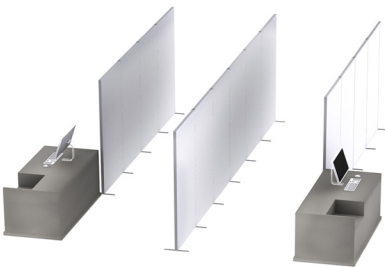

OPTIONAL TPU MATERIAL



STRAIGHT CONNECTION

QSEG QUEUE STRAIGHT DOUBLE TPU

QSEG MODULAR SEG DISPLAY
 PRODUCT CODE: QSEGSTRQUEUE-2L-CWG



On frame On graphic

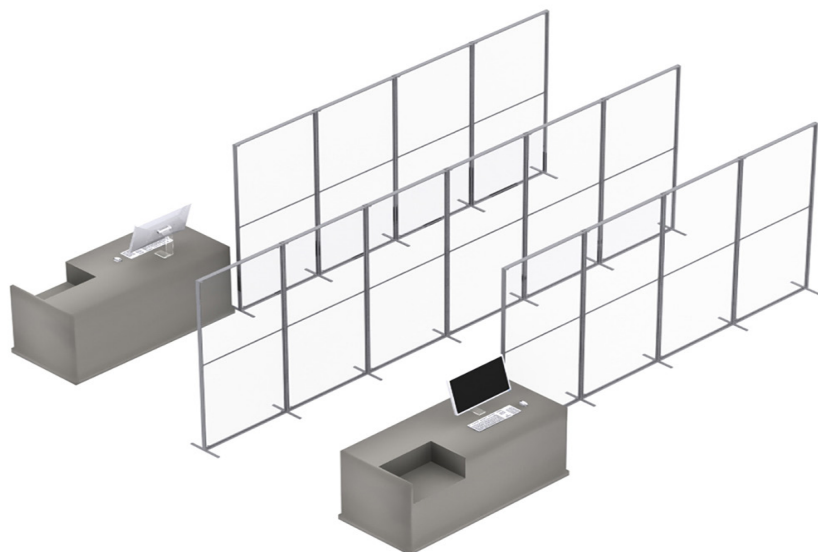

PRODUCT DESCRIPTION

Use Qseg for social distancing solutions for work environments as office partitions and cubicles. Help keep safe physical distance between employees and customers with today's health and safety regulations. By strategically placing our lightweight and portable walls. Padded travel bags are included to keep your frames and graphics protected during transport and storage. With many wall sizes and connector accessories. Effortlessly creating numerous configurations that meet your needs. Connector options are either 2 way (90°) or 4 way (180°) Other graphic options are full custom printed dye sublimated graphics or TPU plastic for hygienic sneeze guards and partitions.

DISPLAY DIMENSIONS	236.25"W x 88.5"H (depth varies)
GRAPHIC SIZE (each frame)	41.5" x 91"

GRAPHIC MATERIAL

Clear TPU Plastic

GRAPHIC FINISHING

Silicone beading sewn onto edge of graphic

DISPLAY CONSTRUCTION

Aluminum extrusion frame with plastic components

SHIPPING WEIGHTS & DIMENSIONS

Shipping Weight (each box)	16 lbs (SEGO-100x225) (2 box)
	40 lbs (SEGO-300x225) (4 boxes)
Shipping Dimensions (each box)	47.25"W x 4"H x 10.25"D (2 box)
	47.25"W x 10.25"H x 10.25"D (4 boxes)

GRAPHIC TURN AROUND TIME

2 business days after proof approval (up to 2 sets)

AVAILABILITY	PFC
--------------	-----

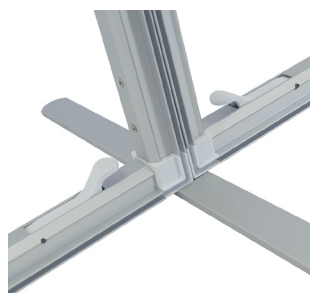
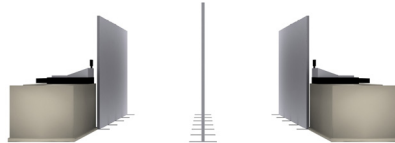
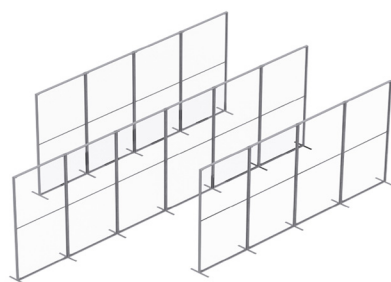

DUAL FOOT CONNECTION



DOUBLE FOOT

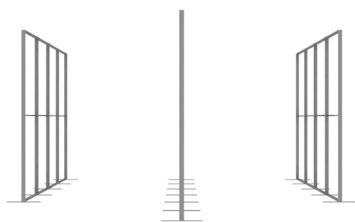

OPTIONAL TPU MATERIAL



STRAIGHT CONNECTION

QSEG QUEUE STRAIGHT DOUBLE TPU + BLANK

QSEG MODULAR SEG DISPLAY
 PRODUCT CODE: QSEGSTRQUEUE-2L-HUCWG



On frame On graphic

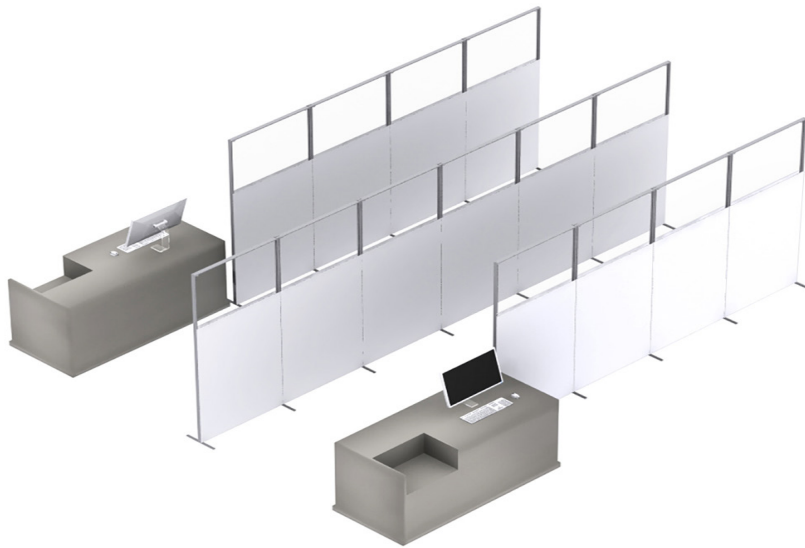

PRODUCT DESCRIPTION

Use Qseg for social distancing solutions for work environments as office partitions and cubicles. Help keep safe physical distance between employees and customers with today's health and safety regulations. By strategically placing our lightweight and portable walls. Padded travel bags are included to keep your frames and graphics protected during transport and storage. With many wall sizes and connector accessories. Effortlessly creating numerous configurations that meet your needs. Connector options are either 2 way (90°) or 4 way (180°). Other graphic options are full custom printed dye sublimated graphics or TPU plastic for hygienic sneeze guards and partitions.

DISPLAY DIMENSIONS	236.25"W x 88.5"H (depth varies)
GRAPHIC SIZE (each frame)	41.5" x 91"

GRAPHIC MATERIAL

Clear TPU Plastic and Unprinted Stretch Fabric

GRAPHIC FINISHING

Silicone beading sewn onto edge of graphic

DISPLAY CONSTRUCTION

Aluminum extrusion frame with plastic components

SHIPPING WEIGHTS & DIMENSIONS

Shipping Weight (each box)	16 lbs (SEGO-100x225) (2 box)
	40 lbs (SEGO-300x225) (4 boxes)
Shipping Dimensions (each box)	47.25"W x 4"H x 10.25"D (2 box)
	47.25"W x 10.25"H x 10.25"D (4 boxes)

GRAPHIC TURN AROUND TIME

2 business days after proof approval (up to 2 sets)

AVAILABILITY	PFC
--------------	-----

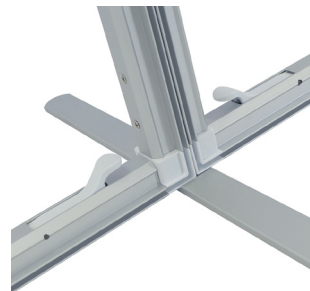
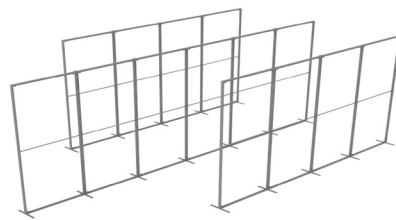

DUAL FOOT CONNECTION



DOUBLE FOOT

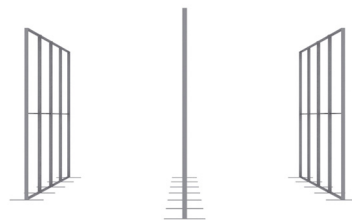
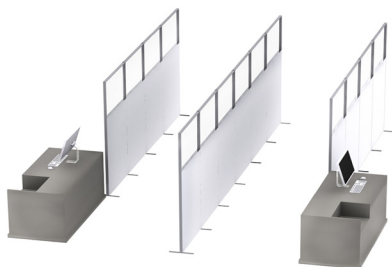

OPTIONAL TPU MATERIAL



STRAIGHT CONNECTION

QSEG QUEUE STRAIGHT DOUBLE TPU + PRINT

QSEG MODULAR SEG DISPLAY
 PRODUCT CODE: QSEGSTRQUEUE-2L-HPCWG



On frame On graphic

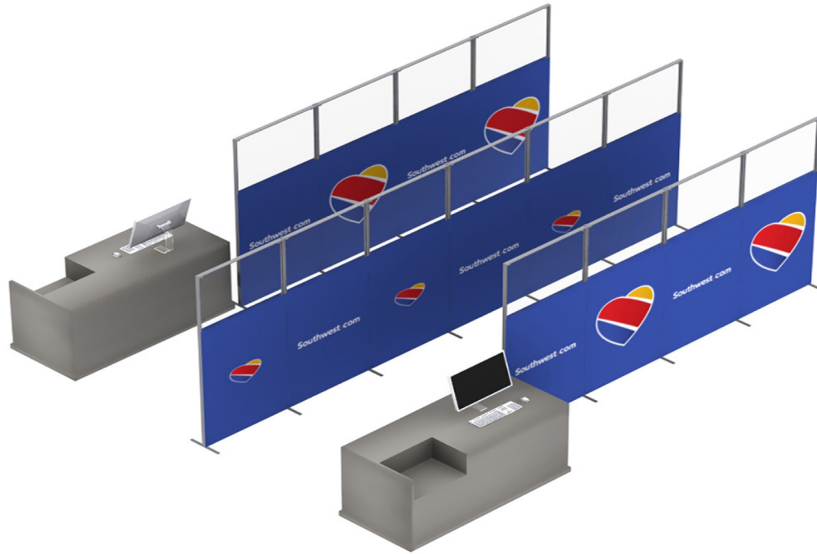

PRODUCT DESCRIPTION

Use Qseg for social distancing solutions for work environments as office partitions and cubicles. Help keep safe physical distance between employees and customers with today's health and safety regulations. By strategically placing our lightweight and portable walls. Padded travel bags are included to keep your frames and graphics protected during transport and storage. With many wall sizes and connector accessories. Effortlessly creating numerous configurations that meet your needs. Connector options are either 2 way (90°) or 4 way (180°). Other graphic options are full custom printed dye sublimated graphics or TPU plastic for hygienic sneeze guards and partitions.

DISPLAY DIMENSIONS	236.25"W x 88.5"H (depth varies)
GRAPHIC SIZE (each frame)	41.5" x 91"

GRAPHIC MATERIAL

Clear TPU Plastic and Dye Sub Stretch Fabric

GRAPHIC FINISHING

Silicone beading sewn onto edge of graphic

DISPLAY CONSTRUCTION

Aluminum extrusion frame with plastic components

SHIPPING WEIGHTS & DIMENSIONS

Shipping Weight (each box)	16 lbs (SEGO-100x225) (2 box)
	40 lbs (SEGO-300x225) (4 boxes)
Shipping Dimensions (each box)	47.25"W x 4"H x 10.25"D (2 box)
	47.25"W x 10.25"H x 10.25"D (4 boxes)

GRAPHIC TURN AROUND TIME

2 business days after proof approval (up to 2 sets)

AVAILABILITY	PFC
--------------	-----

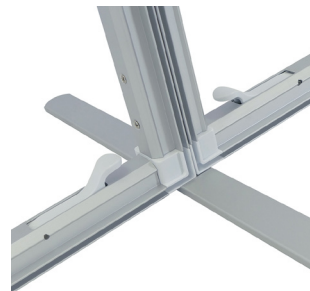
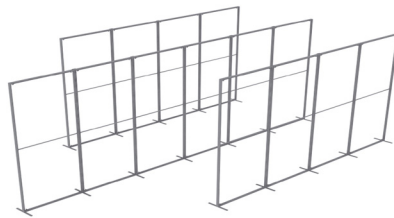
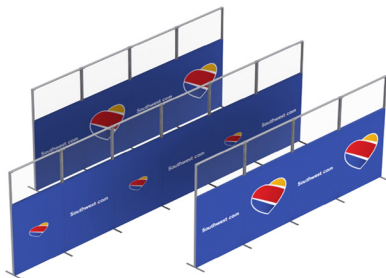

DUAL FOOT CONNECTION



DOUBLE FOOT

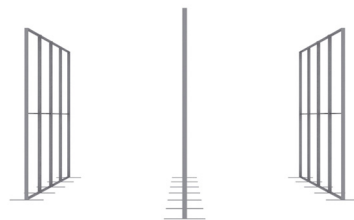
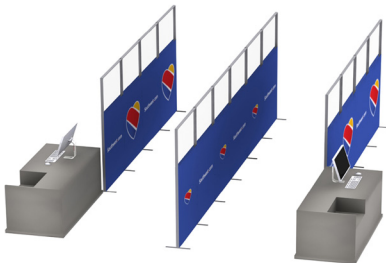

OPTIONAL TPU MATERIAL



STRAIGHT CONNECTION

QSEG QUEUE STRAIGHT DOUBLE

QSEG MODULAR SEG DISPLAY
PRODUCT CODE: QSEGSTRQUEUE-2L



On frame



On graphic



PARTS LIST

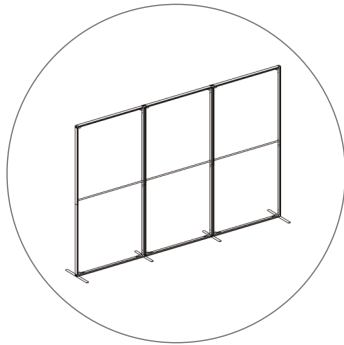

(qty 4)
QSEG-300x225

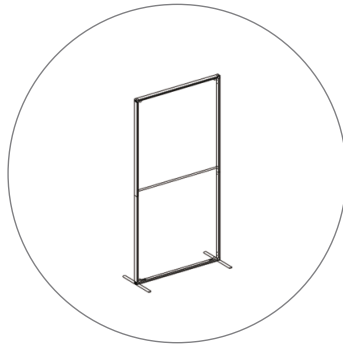

(qty 2)
QSEG-100x225

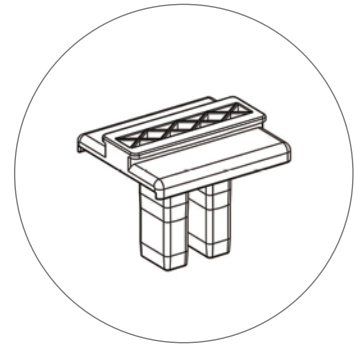

(qty 3)
QSEG-SCON

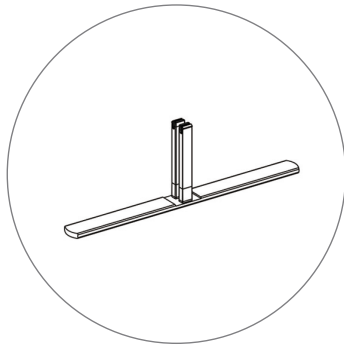

(qty 3)
QSEG-TPF

QSEG QUEUE STRAIGHT DOUBLE

QSEG MODULAR SEG DISPLAY
PRODUCT CODE: QSEGSTRQUEUE-2L



On frame



On graphic



SET UP INSTRUCTIONS DOUBLE FRAME ASSEMBLY

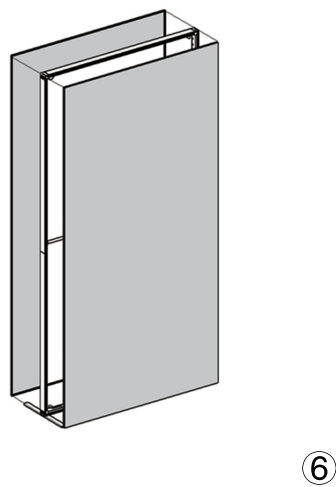
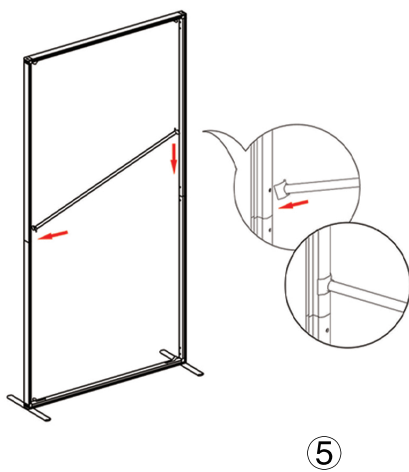
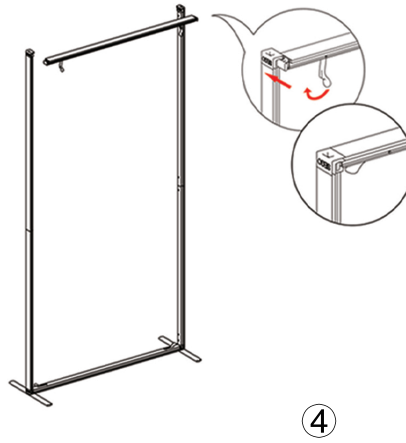
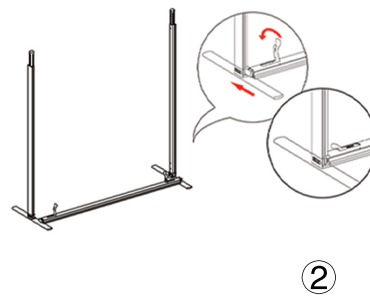
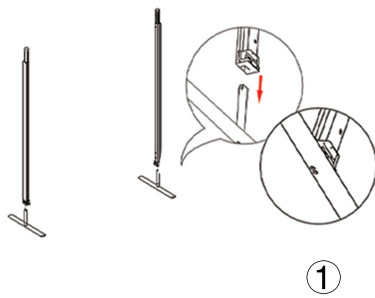

QSEG QUEUE STRAIGHT DOUBLE

QSEG MODULAR SEG DISPLAY
PRODUCT CODE: QSEGSTRQUEUE-2L



On frame



On graphic



SET UP INSTRUCTIONS FRAME CONNECTION

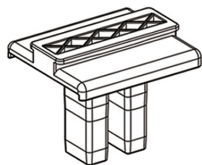
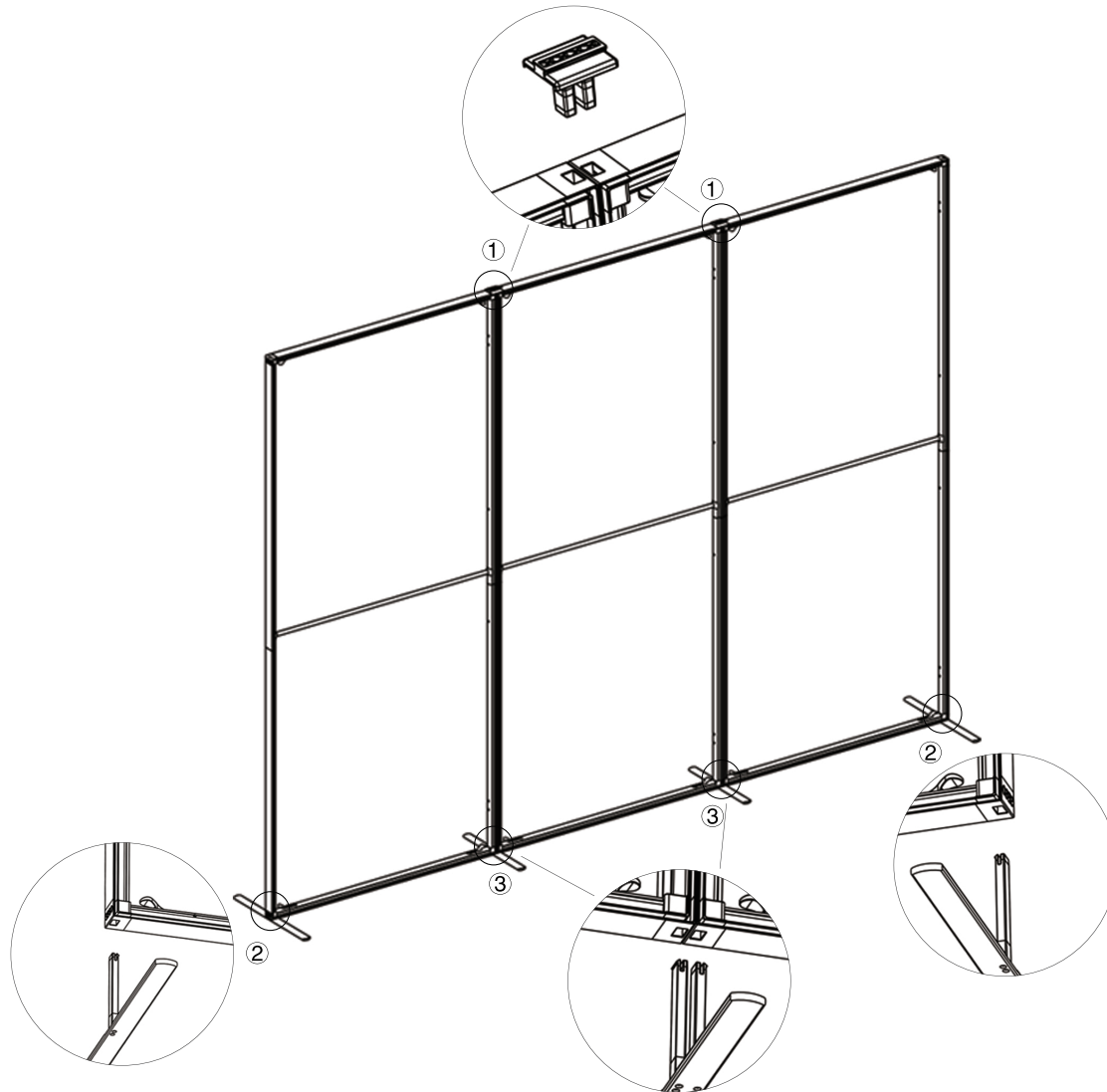

① Straight Connector

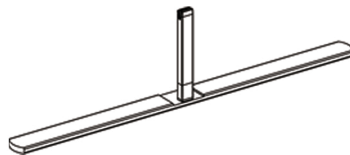

② Foot

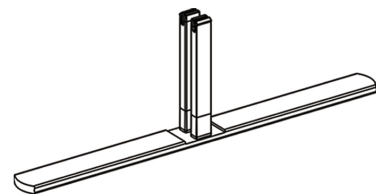

③ Twin Pole Foot

QSEG QUEUE STRAIGHT DOUBLE

QSEG MODULAR SEG DISPLAY
 PRODUCT CODE: QSEGSTRQUEUE-2L-FCPG



On frame On graphic

TEMPLATE

PLEASE DELETE ALL TEMPLATE ELEMENTS BEFORE UPLOADING

QSEG QUEUE LINE STRAIGHT DOUBLE

GRAPHIC DIMENSIONS: 41.5"W x 91" H
 YELLOW SAFE AREA: 33.5"W x 83" H

UPLOAD AT 100% SCALE
 DOCUMENT SIZE 41.5" x 91"

USE TEMPLATE 28 TIMES TOTAL (14 FRONT/14 BACK)
 REFERENCE TEMPLATE GUIDE FOR TEMPLATE LOCATIONS
 ANY CONTINUOUS ARTWORK TO MATCH UP OR LINE UP
 WITH ANOTHER PRINT MAY NOT LINE UP PERFECTLY

*KEEP ALL IMPORTANT GRAPHICS
 SUCH AS: LOGOS, TEXT, CONTACT INFO, ETC.
 IN THE YELLOW SAFE ZONE*

*ARTWORK IN THE BLUE AREA WILL PRINT BUT IS IN RISK
 OF BEING CLOSE TO THE EDGE OR TRIMMED OFF*

Graphic Specifications:

- Create to template specs
- 125 DPI resolution
- CMYK color
- No template lines
- Embed/link all images
- Create to outline all fonts

Acceptable file formats:

- Photoshop (.psd, .psb)
- Illustrator (.ai, .eps)
- Flattened .tiff
- Press quality .pdf

Ver-0622.20

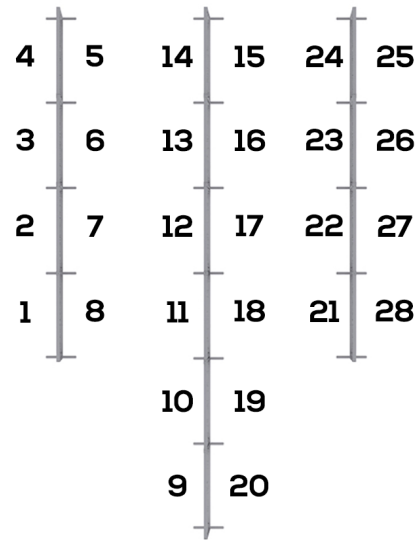
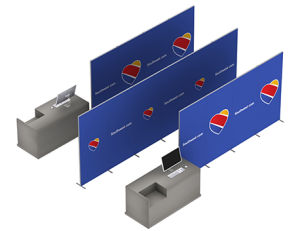

AERIAL FRAME VIEW

NUMBERS ON THE IMAGE ABOVE INDICATE THE TEMPLATE LOCATION # ON FRAME
 PLEASE ADD TEMPLATE LOCATION # TO END OF FILENAME. EX: "QSEG-QUEUESTRAIGHT-DOUBLE-1"

QSEG QUEUE STRAIGHT DOUBLE TPU + PRINT

QSEG MODULAR SEG DISPLAY
 PRODUCT CODE: QSEGSTRQUEUE-2L-HPCWG



On frame



On graphic



TEMPLATE

PLEASE DELETE ALL TEMPLATE ELEMENTS BEFORE UPLOADING

QSEG QUEUE STRAIGHT DOUBLE TPU
 GRAPHIC DIMENSIONS: 41.5"W x 63" H
 YELLOW SAFE AREA: 33.5"W x 55" H

UPLOAD AT 100% SCALE
 DOCUMENT SIZE 41.5" x 63"

USE TEMPLATE 28 TIMES TOTAL (14 FRONT/14 BACK)
 REFERENCE TEMPLATE GUIDE FOR TEMPLATE LOCATIONS
 ANY CONTINUOUS ARTWORK TO MATCH UP OR LINE UP
 WITH ANOTHER PRINT MAY NOT LINE UP PERFECTLY

GRAPHIC WILL BE BOTTOM HALF OF PANEL
 CLEAR TPU PLASTIC WILL BE SEWN TO TOP
 *TPU PORTION NOT PICTURED ON TEMPLATE

KEEP ALL IMPORTANT GRAPHICS
 SUCH AS: LOGOS, TEXT, CONTACT INFO, ETC.
 IN THE YELLOW SAFE ZONE

ARTWORK IN THE BLUE AREA WILL PRINT BUT IS IN RISK
 OF BEING CLOSE TO THE EDGE OR TRIMMED OFF

Graphic Specifications:
 - Create to template specs
 - 125 DPI resolution
 - CMYK color
 - No template lines
 - Embed/link all images
 - Create to outline all fonts

Acceptable file formats:
 - Photoshop (.psd, .psb)
 - Illustrator (.ai, .eps)
 - Flattened .tiff
 - Press quality .pdf

Ver-0622.20



QUEUE STRAIGHT DOUBLE TEMPLATE GUIDE

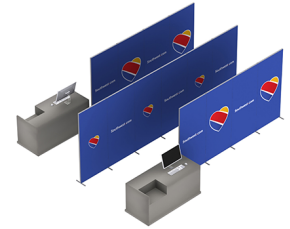

SIDE FRAME VIEW

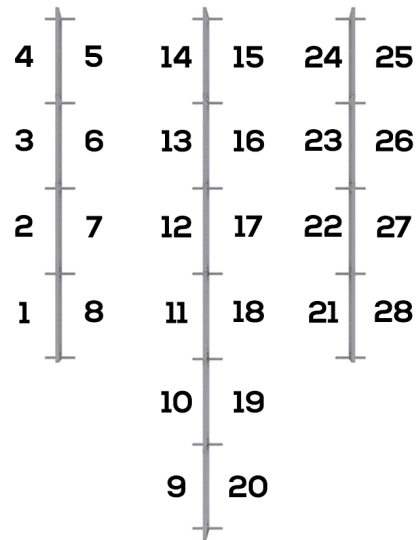

AERIAL FRAME VIEW

NUMBERS ON THE IMAGE ABOVE INDICATE THE TEMPLATE LOCATION # ON FRAME
 PLEASE ADD TEMPLATE LOCATION # TO END OF FILENAME. EX: "QSEG-QUEUESTRAIGHT-DOUBLE-1"